

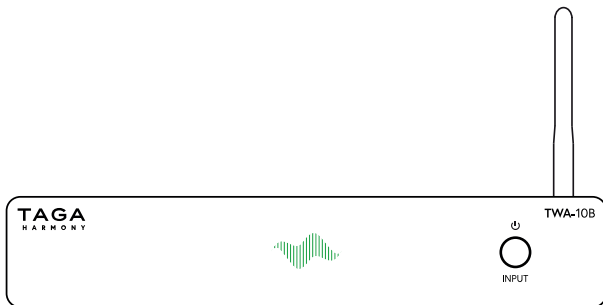

TAGA
H A R M O N Y

TWA-10B

NETWORK PLAYER



Instruction Manual

Edition 03-2024

Firmware version: 4.6.606043.48

Introduction

Thank you for purchasing this TAGA Harmony Network Player.

TAGA Harmony TWA-10B allows to stream digital music content from smartphones, tablets, music libraries on computers or network storage, as well as from the best online streaming services and internet radio.

The TWA-10B can be quickly and easily connected to your existing audio system and transform it to a thrilling digital smart system!

KEY FEATURES:

- With Apple AirPlay, you can enjoy your favorite music in any room.
- **Wi-fi** and **Bluetooth**® to wirelessly stream music from smartphones, tablets, computers, online streaming services and internet radio.
- Support of many **online streaming services** (incl. Spotify Connect, Tidal Connect) and **Internet radio** to enjoy the best music and broadcasts from around the world.
- Compatibility with **high-resolution** sources up to 24bit/192kHz (via wi-fi).
- High-quality sound utilizing **ESS SABRE Premier Stereo DAC** ES9023 with Hyperstream™ architecture and Time Domain Jitter Eliminator.
- Support of a wide range of formats including high-resolution **lossless FLAC and ALAC**, and **uncompressed WAV** to get the most natural and detailed sound.
- **Compatible with any devices with audio** inputs such as amplifiers, receivers, audio systems, soundbars etc. through 3 stereo outputs: gold-plated analog RCA, digital Optical and gold-plated digital Coaxial.
- Compact size and elegant design utilizing **aluminum housing** to match with any device.
- **Streaming via free applications** (for instance 4STREAM, WiiM Home) available on the Apple App Store and the Google Play® Store.
- Selected apps provide **multiroom** features - you can enjoy music simultaneously on multiple TWA-10B players or other compatible devices in different zones and control them via a single app interface.

Introduction

Cleaning

Do not use strong or abrasive cleaners. Use a damp, soft cloth for cleaning.

Specifications and the latest instruction manual edition

Full technical specifications and the latest edition of the instruction manual are available on **www.TagaHarmony.com**

Contents

Safety Instructions	5
Front and Rear Panel	8
Hooking Up the Network Player	10
Input Indicator Status	12
Connection Options - Bluetooth ® Wireless (wi-fi) LAN Wired	12
Connection Options - Apple AirPlay	18
Operation	18
Control Application	20
Playback from computers	32
Interferences with tube devices	32
Trademarks and Software Notice	33
Kit Content	34
Serial Number and MAC Address	34
Specifications	34

Safety Instructions

IMPORTANT

READ THIS SECTION CAREFULLY BEFORE PROCEEDING!



An exclamation mark in a triangle is intended to alert the user to the presence of important operating and maintenance (servicing) instructions in the literature accompanying the appliance.

WARNING: TO REDUCE THE RISK OF FIRE OR ELECTRIC SHOCK, DO NOT EXPOSE THIS APPARATUS OR THE POWER ADAPTER TO RAIN OR MOISTURE, AND OBJECTS FILLED WITH LIQUIDS, SUCH AS VASES, SHOULD NOT BE PLACED ON THIS APPARATUS OR ON THE POWER ADAPTER.

CAUTION: TO PREVENT ELECTRIC SHOCK, FULLY AND SECURELY INSERT THE POWER PLUG INTO THE POWER OUTLET, AND THE POWER CABLE CONNECTORS INTO THE UNIT AND THE POWER ADAPTER SOCKETS (IF THE POWER ADAPTER IS NOT EQUIPPED WITH AN INTEGRATED [ATTACHED] POWER CORDS).

CAUTION: FOR CONTINUED PROTECTION AGAINST RISK OF FIRE, REPLACE THE FUSE (IF THE UNIT OR THE POWER ADAPTER IS EQUIPPED WITH A USER REPLACEABLE FUSE) ONLY WITH THE SAME AMPERAGE AND VOLTAGE TYPE. IN CASE WHEN THE UNIT OR THE POWER ADAPTER IS NOT EQUIPPED WITH A USER REPLACEABLE FUSE - REFER REPLACEMENT TO QUALIFIED SERVICE PERSONNEL.

WARNING: THE UNIT AND THE POWER ADAPTER MAY BECOME HOT. ALWAYS PROVIDE ADEQUATE VENTILATION TO ALLOW FOR COOLING. DO NOT PLACE THE UNIT AND THE POWER ADAPTER NEAR A HEAT SOURCE, OR IN SPACES THAT CAN RESTRICT VENTILATION.

Safety Instructions

1. Read Instructions - All the safety and operating instructions should be read before the product is operated.
2. Retain Instructions - The safety and operating instructions should be retained for future reference.
3. Heed Warnings - All warnings on the product and in the operating instructions should be adhered to.
4. Follow Instructions - All operating and use instructions should be followed.
5. Cleaning - Unplug this product from the power outlet before cleaning. Do not use liquid cleaners or aerosol cleaners.
6. Water and Moisture - Do not use this product near water - for example, near a bath tub, wash bowl, kitchen sink or laundry tub; in a wet basement; or near a swimming pool; and the like. These precautions also apply to the power cords and power adapter.
7. Accessories - Do not place this product on an unstable cart, stand, tripod, bracket or table. The product may fall, causing serious injury to a child or adult and serious damage to the product. Use only with a cart, stand, tripod, bracket or table recommended by the manufacturer or sold with the product. Any mounting of the product should follow manufacturer's instructions and should use a mounting accessory recommended by the manufacturer.
8. Ventilation - This unit may be equipped with slots and openings in the cabinet (housing) which are provided for ventilation and to ensure reliable operation of the product and to protect it from overheating and these openings must not be blocked or covered. The openings should never be blocked by placing the product on a bed, sofa, rug or other similar surface. This product should be not placed in a built-in installation such as a bookcase or rack unless proper ventilation is provided or the manufacturer's instructions have been adhered to. For products equipped with separate power adapters, leave at least 5cm (2in.) of free space on all sides and the top of the power adapter.
9. Power Sources - This product should be operated only from the type of power source indicated on the marking label (placed on the product and / or, if applicable, on a separate power adapter unit). If you are not sure of the type of power supply in your home, consult your product dealer or local power company. For products intended to operate from battery power or other sources, refer to the operating instructions.
10. Grounding and Polarity - some units for proper operation or to take full advantage of their capabilities may require to be connected to a grounded power outlet – refer to the user manual for more information.
Some units or power adapters may have markings for the live (L) and neutral (N) conductors for power - in order to take full advantage of capabilities of such products, it is recommended to properly connect the polarity according to the markings on the unit - refer to the user manual for more information. Connecting the polarity not in accordance with the markings will not affect the durability and reliability of the device.
11. Power-cord Protection - Power supply cords should be routed so that they are not likely to be walked on or pinched by items placed upon or against them, paying particular attention to cords at plugs, convenience receptacles and the point where they exit from the product or the power adapter.
12. Lighting - For added protection for this product during a lighting storm or when it is left unattended and unused for long periods of time, unplug it from the wall outlet and disconnect the antenna or system cables. This will prevent damage to the product due to lighting and power-line surges.
13. Overloading - Do not overload wall outlets, extension cords or integral convenience receptacles as this can result in a risk of fire or electric shock.
14. Object and Liquid Entry - Never push objects of any kind into this product through openings as they may touch dangerous voltage points or short-out parts that could result in a fire or electric shock. Do not expose this apparatus and the power adapter to dripping or splashing and ensure that no objects filled with water, such as vases are placed on the apparatus or on the power adapter.
15. Servicing - Do not attempt to service this product yourself as opening or removing covers may expose you to dangerous voltage or other hazards. Refer all servicing to qualified service personnel.

Safety Instructions

16. Damage Requiring Service - Unplug this product from wall outlet and refer servicing to qualified personnel under the following conditions:
 - when power supply cords or plugs are damaged;
 - if liquid has been spilled or objects have fallen into the product;
 - if the product does not operate normally by following the operating instructions. Adjust only those controls that are covered by the operating instructions as an improper adjustment of other controls may result in damage and will require extensive work by a qualified technician to restore the product to its normal operation;
 - if the product has been dropped or damaged in any way;
 - if the product exhibits a distinct change in performance - this indicates a need for a service.
17. Replacement Parts - when replacement parts are required, be sure the technician has used replacement parts specified by the manufacturer or with the same characteristics as the original part. Unauthorized substitutions may result in fire, electric shock or other hazards.
18. Safety Check - Upon completion of any service or repairs to this product, ask the service technician to perform safety check to determine that the products is in proper operating condition.
19. Wall of ceiling mounting - The product should be mounted to a wall or ceiling only as recommended by the manufacturer.
20. Heat - The power adapter should be situated away from heat sources such as radiators, heat registers, stoves or other products that produce heat.
21. [Refer to products equipped with vacuum tubes] Tube Cage or cover - For your safety and to protect the vacuum tubes this product may be equipped with the factory installed vacuum tube cage or cover.

It is not recommended to remove the cage or cover unless it is required to change the vacuum tubes.
When the cage or cover is removed - do not touch the vacuum tubes - they may be hot and burn the skin!
22. Operating Environment - Operating environment temperature and humidity of the unit: +5°C to +35°C (+41°F to +95°F); less than 85% RH (cooling slots not blocked).



PACKAGING WARNING

The packaging may contain elements such as plastic, that **should be kept away from small children.**

The thin foil or small elements can stick to the nose and mouth, or may be swallowed and prevent breathing.

Front and Rear Panel

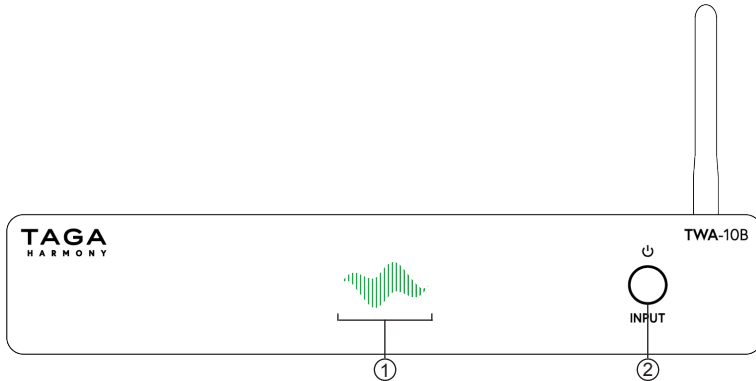

Front Panel:

1. Input Indicator
White – Network: Wireless (wi-fi) and Wired (LAN), Blue – **Bluetooth**[®],
Green – Spotify connect, Red – Standby mode
2. Touch 2-function Button:
 - Standby Button
To turn the unit ON (when it is OFF) - press once
 - To turn the unit OFF - long press
 - Input (Source) Selection Button - short press to select inputs

Note! The Touch 2-function Button is sensitive to electromagnetic radiation from external electrical appliances. If you encounter any problems with its operation: disconnect the power adapter and place the Network Player away from potential sources of interferences.

Front and Rear Panel

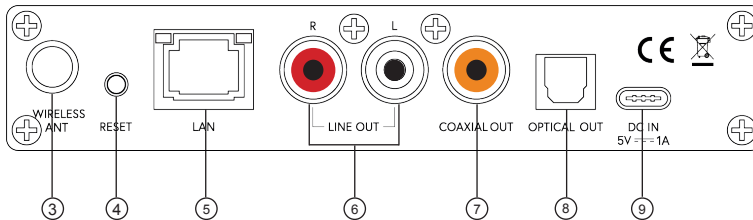

Rear Panel:





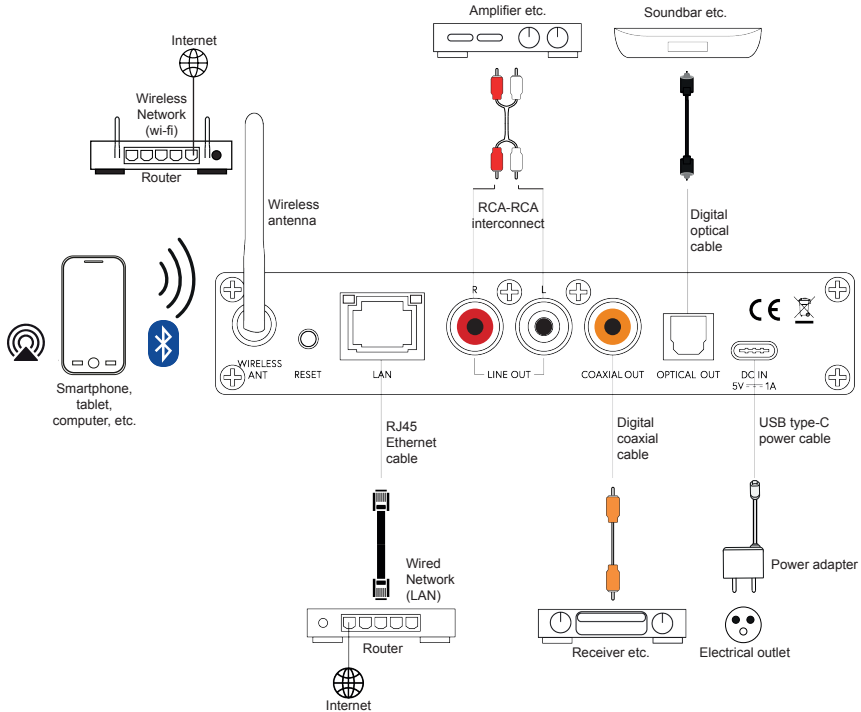

3. Wireless (wi-fi and **Bluetooth**[®]) Antenna Socket
4. Connections Reset Button
 - Short press once – configuration (setup) of the Wireless (wi-fi) connection
 - Short press twice – pairing with **Bluetooth**[®] connection
 - Long press – reset of both connections (wi-fi and **Bluetooth**[®])
5. Wired connection to the local network device
6. Analog Stereo RCA Output (R and L)
7. Digital Coaxial Output
8. Digital Optical Output
9. USB type-C DC Power Input

Hooking Up the Network Player

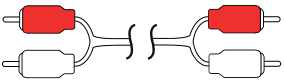

Hooking Up the Network Player

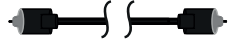

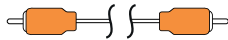

1. Make sure the Network Player is turned off (the power adapter is disconnected from the electrical outlet).
2. Make sure that external equipment which will be connected to the Network Player is turned off.
3. Screw in the antenna into the Wireless antenna socket.
Note! Make sure the antenna is securely and firmly installed – otherwise the wi-fi or **Bluetooth®** connection may not be established or may be unstable.
4. If you want to connect to the local area network by wire: using an RJ45 Ethernet cable connect the Network Player to your local network device (router, access point etc.). Check “Connection Options” for more details.
5. External audio equipment connection options:

Signal	TWA-10B Output	Audio equipment Input	Connection cable
Analog	LINE OUT 	RCA sockets 	RCA-RCA interconnect (supplied) 
Digital	OPTICAL OUT 	Optical socket 	Optical cable (not supplied) 
	COAXIAL OUT 	Coaxial socket 	Coaxial cable (not supplied) 

The sockets shown for external equipment and connection options may differ depending on the device.

6. Apple AirPlay - check “Connection Options - Apple AirPlay” for more details.
7. If you want to stream music via Wireless (wi-fi) or **Bluetooth®** from compatible devices check “Connection Options” for more details.

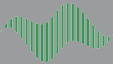
Input Indicator Status

Color	Input / Mode	Indication	Status
White 	Wireless (wi-fi) LAN	Flashing rapidly	System is booting
		Flashing slowly	System is ready
		Illuminated continuously	Wireless (wi-fi) or LAN connected
Blue 	Bluetooth®	Flashing rapidly	System is booting
		Flashing slowly	System is ready
		Illuminated continuously	Bluetooth® connected
Green 	Spotify connect	Illuminated continuously	Spotify connected
Red 	Standby mode	Illuminated continuously	System in the Standby mode (the unit turned off)

Connection Options

The Network Player device name is “TWA-10B #####”, where ##### is 4 last hex digits of its unique MAC address.

BEFORE BEGINNING

1. After turned on for the first time or after restoring factory setting, the Network Player will start in the **Bluetooth®** input.
2. Make sure that your local network device (router, access point etc.) is connected to the Internet.
3. Download the Control Application for mobile devices - check “Control Application” for more details.

Connection Options

- Make sure to activate the following options in your audio source device setup (mobile devices and computers):

	Wi-fi	GPS	Bluetooth®
Mobile device	✓	✓ (required for the setup)	✓
Computer	✓ (not required for LAN)		✓

Note! The Network Player operates only in 2.4 GHz wireless networks.

- Make sure that the audio source device and the Network Player, and for mobile devices the Control Application as well, are in the same network.
- Turn the Network Player on by pressing the Standby Button.

I. Bluetooth® CONNECTION

- If the Network Player is not in the **Bluetooth®** input – select it in the Control Application or by short pressing the Input (Source) Selection Button on the front panel – the Input Indicator will be flashing in blue. To start pairing short press twice the Reset Button.
- Select **Bluetooth®** in the settings of your audio source device and start scanning for available **Bluetooth®** devices.
- After a short time “TWA-10B ####” will appear on the screen.
- Select “Pair” on your audio source device to connect with the Network Player. After the connection is successful the Input Indicator will be illuminated continuously in blue and it will remain illuminated as long as the current connection is active.
- You can start streaming music.

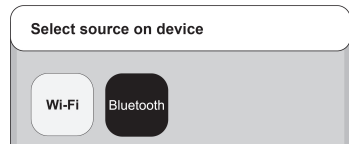

Connection Options

Note!

- The audio source device must be within a range of approximately 5 meters from the Network Player.
- Please refer to your audio source device user instruction for details on operating the **Bluetooth**[®]. Operation and names of specific functions may vary on different devices.
- Make sure the Wireless antenna is securely and firmly installed, and that there are no objects placed between the audio source device and the Network Player obscuring the **Bluetooth**[®] signal which may result in unstable or no connection.
- For some audio source devices it may take a shorter or a longer period of time to reconnect to the Network Player or it may even require to repeat the pairing procedure each time the **Bluetooth**[®] connection is lost.
For most audio source devices the connection will be automatically retrieved.
- When you want to pair another **Bluetooth**[®] audio source device than the currently active, you have to start pairing (short press twice the Reset Button) and restart the **Bluetooth**[®] connection procedure for the new audio source device.
- If your audio source device is not able to find the "TWA-10B ####" **Bluetooth**[®] device or connect to it then start again pairing by short press twice the Reset Button.

II. WIRELESS (wi-fi) CONNECTION (on mobile devices)

Wi-fi connection configuration

1. If the Network Player is not in the Network input – select it by short pressing the Input (Source) Selection Button on the front panel – the Input Indicator will be flashing in white.
To start the configuration (setup) short press once the Reset Button.
2. Open the Control Application - the system will ask for your permission to use multimedia library and files, to find and connect to devices on your local network, to

Connection Options

use your location (GPS), to use **Bluetooth**[®] – accept to continue.

Note! The GPS use permission is required for the setup – once the setup is finished, you can disable it in the settings of your mobile device.

3. Application will start searching for compatible devices and when found will list out all devices available for setup – select the Network Player you want to connect to.

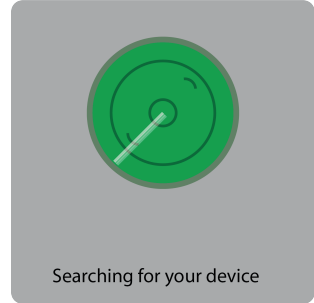

4. The Control Application will list out all networks available for connection – select the one you want to connect to.
5. Enter the password to the selected network.
6. Once the connection is set, the Control Application will automatically check for new updates.
7. You can change the name for the device by selecting from a list or entering your own.
8. The name of the device will be displayed in a list of added devices in the Control Application.
9. You can start streaming music.

If the Control Application cannot find a compatible device automatically

1. Tap on **Add Device**.

Add Device

Connection Options

2. The device setup screen will be displayed with information about the status of the Input Indicator - make sure it is flashing in white (if it is not then start configuring your Wireless (wi-fi) connection one more time - check “Operation” for more details), tap on **indicator is blinking**.



indicator is blinking

Note! Occasionally, it may be required to configure your Wireless (wi-fi) connection again and repeat the search.

3. The Control Application will list out all devices available for setup - select the Network Player you want to configure and tap on **Setup this device**.

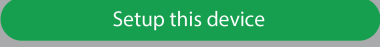

Setup this device

4. Continue with the steps provided in “Wi-fi connection configuration” starting from point 4.

Note!

- Operation and user interface may vary depending on the mobile device model, its operating system and application version.
- Your mobile device may ask for granting permission for the Control Application to access to different mobile device resources.
Make sure to select the correct choices to avoid problems with the configuration.
- If you change the network password for the local network device (router etc.) then you must configure the connection one more time (short press once the Reset Button).
- Make sure the Wireless Antenna is securely and firmly installed, and that there are no objects placed between your local network device and the Network Player obscuring the wireless signal which may result in unstable or no connection.
- Make sure that the Internet transfer speed is sufficient - too slow transfer may cause interruptions in playback of some content.

Connection Options

III. LAN WIRED CONNECTION (on mobile devices)

1. Connect the Network Player with the RJ45 Ethernet cable to your local network device.
2. Open the Control Application - the system will ask for your permission to use multimedia library and files, to find and connect to devices on your local network, to use your location (GPS), to use **Bluetooth**® – accept to continue.
Note! The GPS use permission is required for the setup – once the setup is finished, you can disable it in the settings of your mobile device.
3. Once the connection is set, the Control Application will automatically check for new updates.
4. You can change the name for the device by selecting from a list or entering your own.
5. The device name will be displayed in a list of added devices in the Control Application.
6. You can start streaming music.

ACTIVITY LED		INTERNET LED	
Status	Data	Status	Internet
Off	No	Off	No
Yellow(Blinking)	Yes	Green	Yes

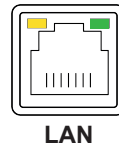

Note!

- Operation and user interface may vary depending on the mobile device model, its operating system and application version.
- Your mobile device may ask for granting permission for the Control Application to access to different mobile device resources.
Make sure to select the correct choices to avoid problems with the configuration.
- LAN connection has priority over the Wireless (wi-fi) connection.
- Make sure that the Internet transfer speed is sufficient - too slow transfer may cause interruptions in playback of some content.

Connection Options - Apple AirPlay

IV. Apple AirPlay CONNECTION

1. Ensure the Network Player is connected to your network.
2. Open the application that you want to stream from, using Apple AirPlay.
3. Select  AirPlay.
4. Select The Network Player as your AirPlay device.
5. You can start streaming music.

To use AirPlay with the Network Player, the latest version of iOS, iPadOS, or macOS is recommended.

Operation

Standby Mode

When you connect the Network Player to the electrical outlet for the first time, it will start in the Standby mode.

Turn ON – press once the Standby Button 

Turn OFF – long press the Standby Button 

Note! The Network Player will start in the last selected input before it was turned off (**Bluetooth**[®] input is default – a new unit or after restoring factory settings).

Input (Source) Selection

When the Network Player is turned on.

Short press the Input (Source) Selection Button to select one of the inputs (sources): Network or **Bluetooth**[®].

The selected input (source) is indicated by a color on the Input Indicator:

White – Network, Blue – **Bluetooth**[®].

Note! You can also change the inputs in the Control Application - check “Control Application” for more details.

Operation

Volume Regulation

You can adjust the level of sound in the Control Application, directly on your audio source device or on the connected external audio equipment.



Distortion and sound quality worsening may occur when the volume level is too high.

It may damage your audio equipment and void the warranty.

When you hear distortion - lower the volume level.

Reset

When the Network Player is turned on.

- I. Wireless (wi-fi) connection configuration (setup) – short press once the Reset Button to configure the connection.
- II. Pairing with **Bluetooth**[®] – short press twice the Reset Button to start pairing.
- III. Reset of both connections (wi-fi and **Bluetooth**[®]) - long press the Reset Button to reset both connections.

Note! After reset the connections, you will have to configure all connections again - check “Connection Options” for more details.

Note! Only the connection settings are reset, other data such as the device name (if changed), login data to streaming and Internet radio services are not reset – to do this, use the Restore factory settings option in the Control Application.

More options and features is available in the Control Application - check “Control Application” for more details.

Control Application

This Network Player may be controlled from a mobile device by third-party applications, such as for instance 4STREAM or WiiM Home, which are available on the Apple App Store and the Google Play® Store.



4STREAM



WiiM Home



Control Application

APPLICATION OPTIONS

Note!

- Settings and operation in this manual are shown based on the 4STREAM application.
- Operation described in this manual is based on the firmware version of the Network Player, which is indicated on the cover page of this instruction manual - it may vary in newer firmware updates.
- Operation and user interface may vary depending on the mobile device model, its operating system, Control Application and its version.
- The application may not be available in your language, some options and descriptions may not be translated or incorrectly translated into your language.

View after starting the Control Application

After the launch, the Control Application will start in the Device option.

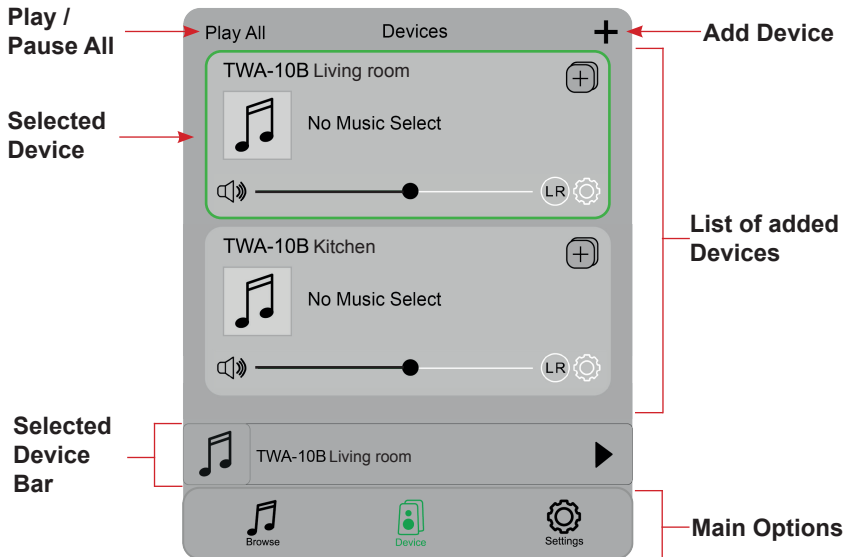

Control Application

MAIN OPTION - DEVICE



Top bar

Play / Pause All

Playback control for all devices.



Add Device

Adding a new Device to the list.

+ When adding a new device, follow the instructions for connecting to the Wireless (Wi-Fi) or Wired (LAN) network provided in „Connection Options”.

List of added Devices

List of all added streaming Devices.

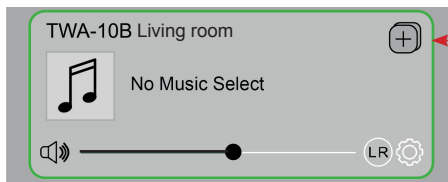

Add / Remove Device to Multiroom

You can group different devices into multiple rooms or zones. For instance, your system consists of 4 streaming devices. You can group devices 1,2 and 3 to play the same music simultaneously, or group devices 1 and 2 as the zone A and devices 3 and 4 as the zone B, and play different music in these zones.

Control Application

Add / Remove a Device to Multiroom

To add:

- Tap on the  icon of the device you want to be the Master device.
- A list of available devices will pop out and you can select the device you want to add as the Slave device.
- Tap on **Done** to confirm.

The gray tick icon represents the Master device and the green tick icon represents the Slave device.

To remove:

- Tap on the  icon again to bring up the device list, and unselect a Slave device you want to remove.
- Tap on **Done** to confirm.

Note! If all Slave devices are removed, the multiroom function will be disabled.

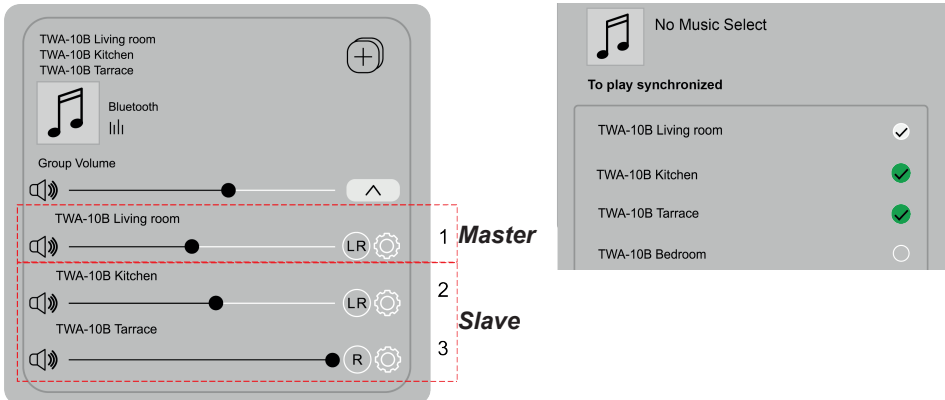

Control Application

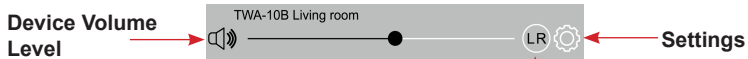

Left and Right Channel

You can configure playback according to below options:

LR - Stereo

L - Only the Left channel of the audio source device is output to both speakers

R - Only the Right channel of the audio source device is output to both speakers



Distortion and sound quality worsening may occur when the volume level is too high.

It may damage your audio equipment and void the warranty.

When you hear distortion - lower the volume level.

Control Application

Settings

Rename:

Change the device name.

EQ: Equalizer function - availability and functionality varies on the Control Application.

Alarm Clock:

Setup up to 4 different alarm clocks with music of your choice.

Note! The alarm clock is not active when the Network Player is turned off and for the

Bluetooth® connection.

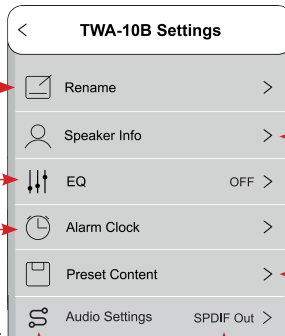

Speaker Info:

Display device information such as a wi-fi status, wi-fi strength, IP an MAC address, SSID, firmware version and **restore factory settings** [resets all connections data, login data to streaming and Internet radio services, restores the default name of the device, etc.], etc.

Active Output

Preset Content:

10 Preset content buttons.

Audio Settings

Tap on **Audio Settings** to open the output selection page.

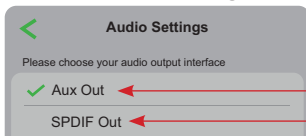

Aux Out (analog LINE output)

SPDIF Out (OPTICAL and COAXIAL outputs)

The currently **Active Output** is indicated with a checkmark (✓).

Note! Audio signal will be transmitted only through the selected output (other outputs will be inactive).

To change the Active Output, tap on the **Aux Out** or **SPDIF Out**.

Control Application

Fade-In & Fade-Out Effects

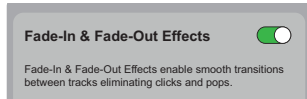

Select this option to enable smooth transition between tracks, eliminating clicks and pops.

SPDIF Out Settings

After SPDIF Out is selected, additional options are available:

Sample rate switch latency (in ms).

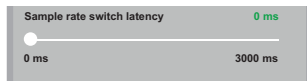

SPDIF Output Resolution

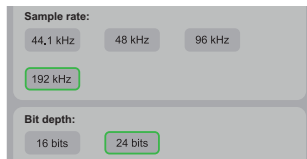

Tap on the desired **Sample rate** and Bit depth and **Done** to save the selection.

Control Application

Operation bar for the Selected Device (available in all main option views)

Tap to open the playback information screen and available features during playback.

Note! Certain features may be different or not available for selected services.

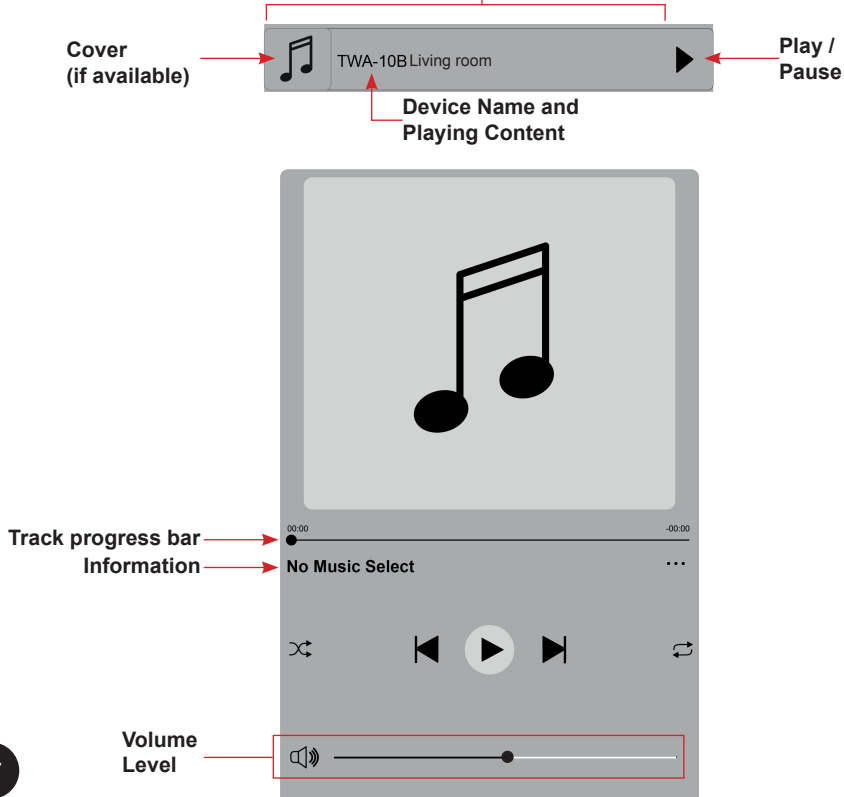

Control Application

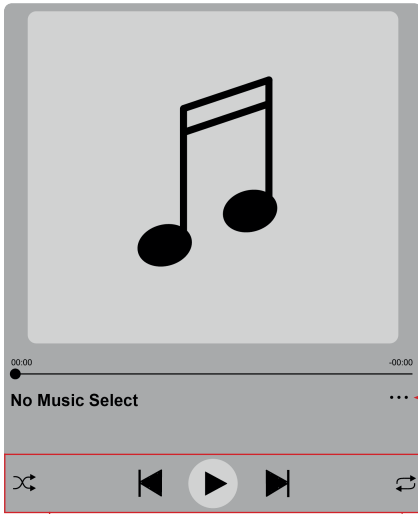

Preset



Add / Remove from favorites



Add to playlist



Alarm



Sleep Timer

Countdown to turn off the playback.



Repeat All



Repeat the song



Random playback



Skip backward / forward



Playlist and Add to Presets Content



Play / Pause playback



Stop playback



Previous / Next track

Control Application

MAIN OPTION - BROWSE



Preset



Preset Content

10 Preset content buttons.

My library



Favorites

Quick access to your favorite playlists on your mobile device.

You can preset up to 10 favorite playlists on the application for easy access.

Note! Playlists are accessible only from the application.



My Music

Playback of music stored on your mobile device.

Playback of music stored on a NAS drive on your network. My Playlists and Recently Played songs.

Note!

- Only NAS drives with the DLNA feature are supported.
- Some content may be protected which will prevent from playing it.

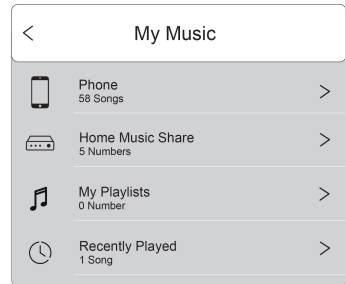
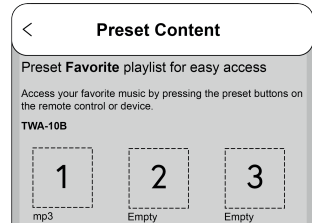

Control Application

Music service

List of added Streaming and Internet Radio Services

Note!

- It may be required to register an account on a service provider platform in order to use their online streaming service.
- Some streaming services and internet radio may require paid subscription.
- Some streaming services and internet radio may not be available in your country.
- Internet access is required.

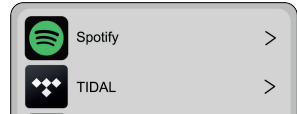

Spotify connect

Use your phone, tablet or computer as a remote control for Spotify.



Go to spotify.com/connect to learn how.



Manage Music services

Add more or remove selected streaming and Internet radio services.



Control Application

Select source on Device

Select the Network (Wi-Fi) or the **Bluetooth**® input (source) for playback.

To change from the **Bluetooth**® source to Network, you can just choose one of the streaming / internet radio services or mobile device local storage music or any music via DLNA or UPnP streaming.

Note! You can also select these sources via the Input (Source) Selection Button on the front panel – check “Operation” for more details.

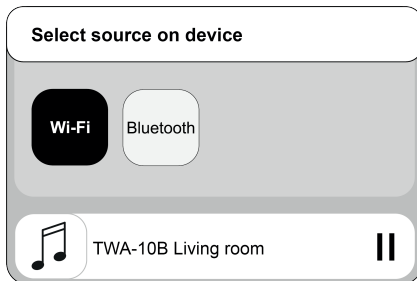

MAIN OPTION – SETTINGS



Control Application version and sending feedback to the app developer.

Firmware Update

When the new firmware is released, you will be notified by an arrow icon shown following the device name in the Control Application.

Tap on the icon to install the firmware.

It's recommended to update the firmware each time it is available.

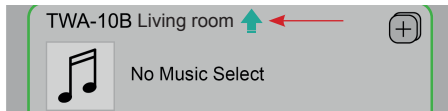

Playback from computers

There are several methods and computer programs compatible with this product which allow to play music from local storage, media library and online services.

Make sure that the Network Player is connected to the Internet and the network connection is configured - check „Connection Options” for more details.

You can use a freeware PC music player for Windows® to play files using UPnP protocol, for instance “foobar2000”.

1. Download “foobar2000” from <https://www.foobar2000.org/> and install it.
2. Install the UPnP component in the Preferences → Components
Follow the installation instructions.
3. After restarting the Foobar2000, choose this Network Player in the Preferences → Playback → Output → Device

Interferences with tube devices

It is a normal phenomenon that the Network Player during the wireless operation may interfere with devices equipped with vacuum tubes (for instance hybrid or tube amplifiers), what results in noises audible in speakers and headphones (in one or both channels).

Try to eliminate such a problem by moving the Network Player away from the tube devices or use the Wired (LAN) connection.

Trademarks and Software Notice

All trademarks and trade names used in this manual are those of their respective owners.

- **Bluetooth®** is a registered trademark of Bluetooth SIG, Inc.
- Windows® is a registered trademark of Microsoft Corporation in the United States and / or other countries.
- The Spotify software is subject to third party licenses found here: <https://www.spotify.com/connect/third-party-licenses>
- TIDAL and TIDAL logo are registered trademark of Aspiro AB in the European Union and other countries.
- Google Play and the Google Play logo are trademarks of Google LLC.

To use AirPlay with the Network Player, the latest version of iOS, iPadOS, or macOS is recommended.

Use of the Works with Apple AirPlay badge means that an accessory has been designed to work specifically with the technology identified in the badge and has been certified by the developer to meet Apple performance standards.

Apple and AirPlay, are trademarks of Apple Inc., registered in the U.S. and other countries and regions.

App Store is a service mark of Apple Inc., registered in the U.S. and other countries.

Third-party applications and software recommended in this manual are provided for your convenience only and should be used at your own risk.

TAGA Harmony does not provide technical support for third party software and does not guarantee their proper operation.

Kit Content

Network Player	1EA
Wireless antenna	1EA
RCA-RCA stereo interconnect	1EA
AC-DC Power Adapter	1EA
USB to micro USB cable	1EA
Instruction Manual	1EA

Serial Number and MAC Address

Product serial number and MAC address are located on the bottom of the Network Player.

Specifications

We strongly advise to contact a professional installer or dealer in order to install TAGA Harmony products.

We recommend using high quality TAGA Harmony cables and other installation accessories.

We reserve the right to change the technical data and the design of the product without notice as a result of further development.

Audio features	<p>DA converter: ESS SABRE ES9023 [audio decode: up to 24bit / 192kHz]</p> <p>Audio output: Wi-Fi: 24bit / 192kHz [for Optical and Coaxial]</p> <p>Bluetooth® 16bit / 44.1kHz [for Optical and Coaxial]</p> <p>Apple AirPlay 16bit / 44.1kHz [for Optical and Coaxial]</p>
Network features	<p>Wi-Fi 802.11 b/g/n 2.4GHz, DLNA, UPnP</p> <p>Apple AirPlay</p> <p>Bluetooth® 5.1</p> <p>RJ45 Ethernet</p>
Streaming services	Spotify Connect, Tidal Connect
Internet radio	Yes
Digital outputs	Optical, Coaxial
Analog outputs	LINE OUT (RCA)
Multiroom	Up to 10 zones (devices) via the mobile app
Supported audio formats	FLAC, WAV, ALAC, APE, MP3
Frequency response	20Hz – 20kHz
Total Harmonic Distortions	<0.01% (1KHz 0dBFS)
Signal / Noise ratio	<p>Wireless: ≥102dB</p> <p>Bluetooth® ≥90dB</p>
Power supply and power consumption	<p>AC-DC Power Adapter 100-240V 50/60Hz, 0.6A [DC output 5V 1A]</p> <p>Standby <0.5W Operation max 5W</p>
Dimensions (H x W x D)	2.4 x 12.9 x 9.4(incl. rear sockets) cm
Weight	0.45 kg / pc.

EU declaration of conformity



Your product is marked with the symbol shown on the left.
As its manufacturer, hereby we declare that the product is in compliance with the following EU directives and regulations:

2014/53/EU (RED) & 1275/2008/EC (ErP) & 2015/863/EU (RoHS).

The full text of the EU declaration of conformity is available from the manufacturer.

Disposal of the product



**Disposal of old electrical & electronic equipment
(applicable in the European Union and other countries with separate
collection systems)**

This symbol on the product or on its literature and packaging indicates that this product shall not be treated as household waste. Instead it shall be handed over to the appropriate collection point for the recycling of electrical and electronic equipment. By ensuring that this product is disposed of correctly, you will help to prevent potential negative consequences for the environment and human health, which could be caused by inappropriate waste handling of this product.

The recycling of materials will help to conserve natural resources. For more detailed information about recycling of this product, please contact your local government office, your household waste disposal service or the shop where you purchased the product.

TAGA EUROPE

POLPAK POLAND Sp. z o.o.

AL.JEROZOLIMSKIE 331A

05-816 REGUŁY k/WARSZAWY, POLAND

Email: Sales@TagaHarmony.com

www.TagaHarmony.com

Notes

Notes

Notes
